

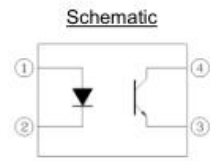

-10

1.

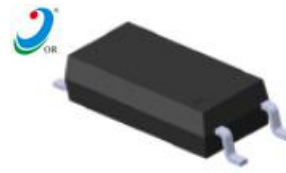

Pin Configuration

- 1. Anode
- 2. Cathode
- 3. Emitter
- 4. Collector

2.

-10

4-

3.

(2)

Parameter	Symbol	Rated Value	Unit
		60	
		125	°C
		6	
		100	
		0	
		7	
		50	
		150	
		250	
*1		5000	
		-55 + 110	
		-55 + 125	°C
*2		260	

*1 1, 2, 3, 4, 40 60% , 1, 2, 3, 4

*2 10



2

Parameter		Symbol	Condition	Min	Typ.*	Max	Unit
			50	---	1.25	1.6	
			4	---	---	10	
			0, 1	---	50	---	
			20 , 0	---	10	100	
			1 0	0	---	---	
			0.1 0	7	---	---	
			5	50	---	600	%
			5	2.5	---	30	
		()	10 1	---	---	0.3	
			500 40 60% . . .	10 ¹²	---	---	
			0, 1	---	0.3	---	
			5 , 2	---	3	1	
			100	---	4.7	1	



9 9U ew5ál -5pu(5æVF#R † a³ ñ0 W“\$DS 2

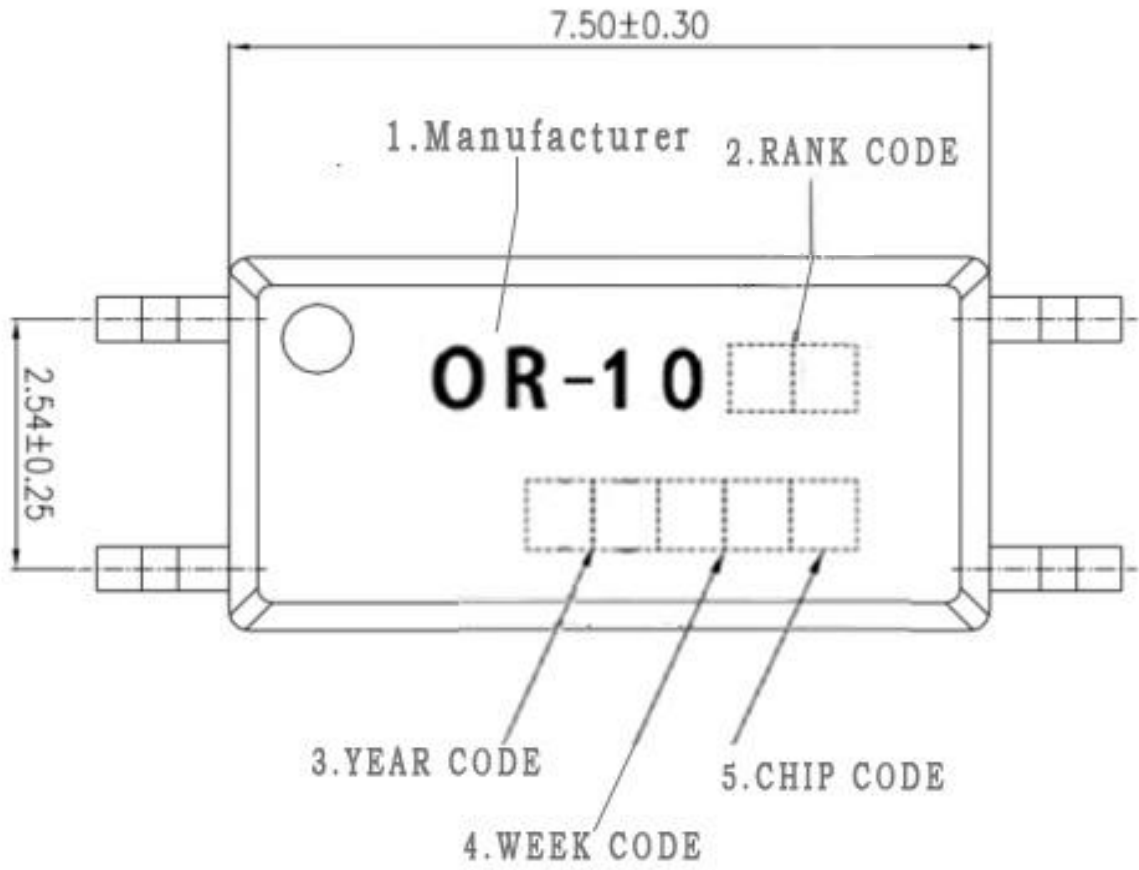

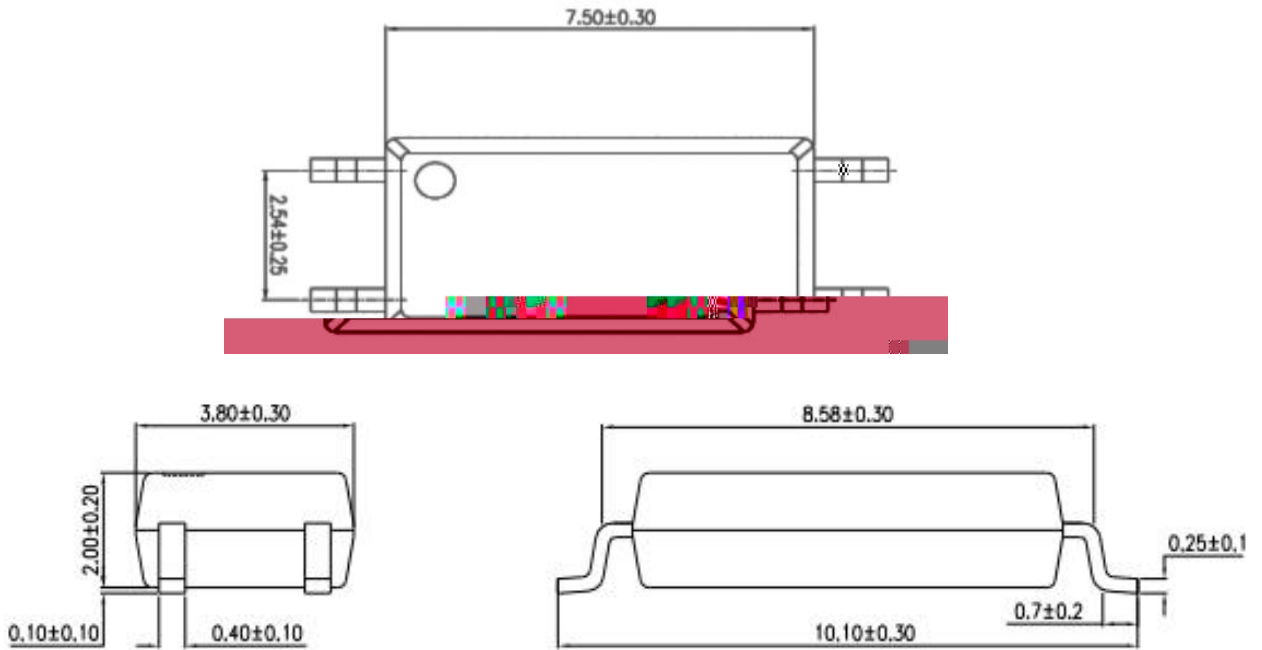

()

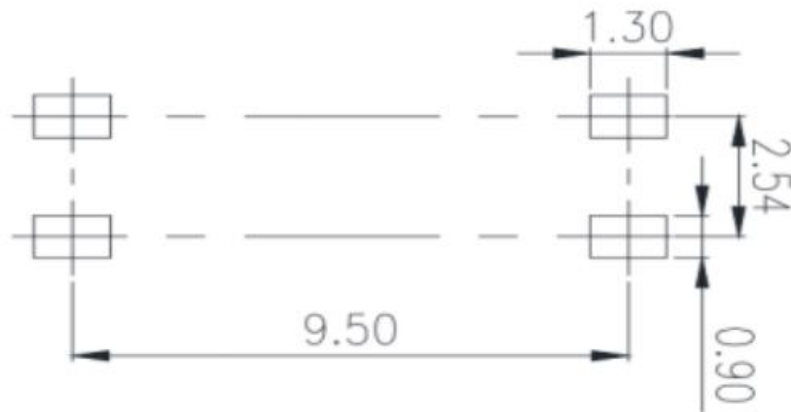

10.

(1) -10 -

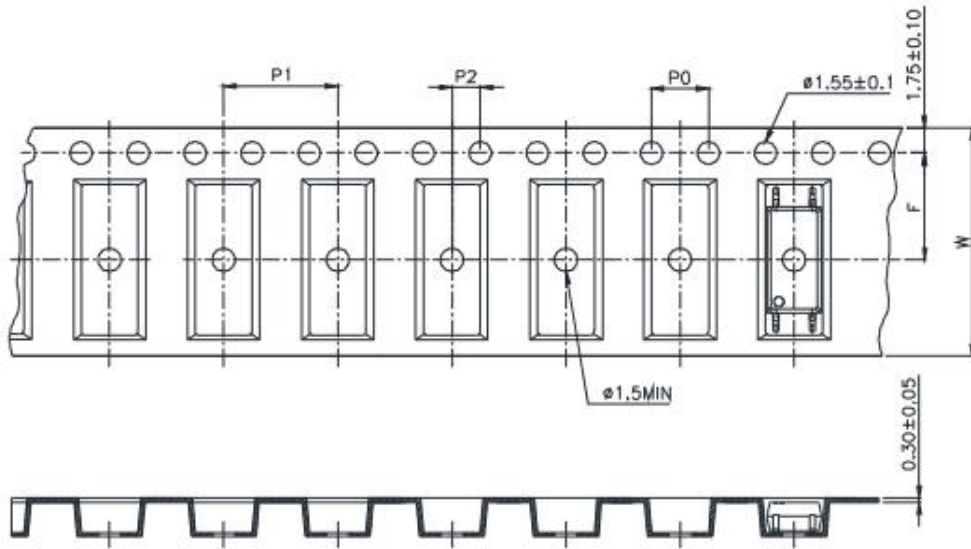

(2) -10 - 1

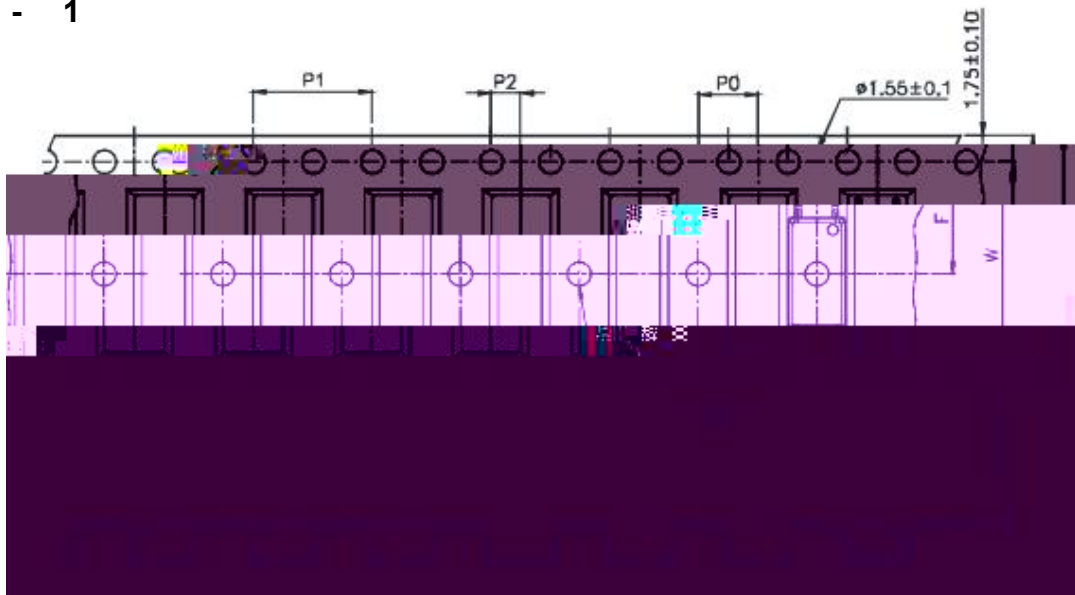

11.

(1). (-020)

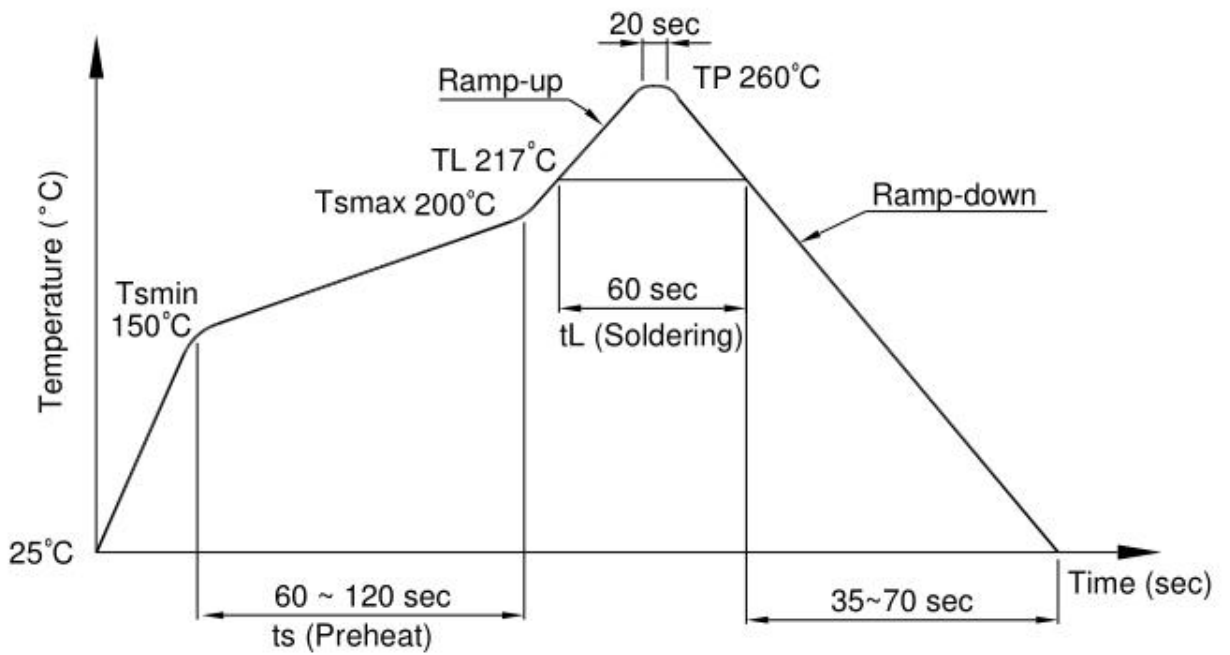

12.

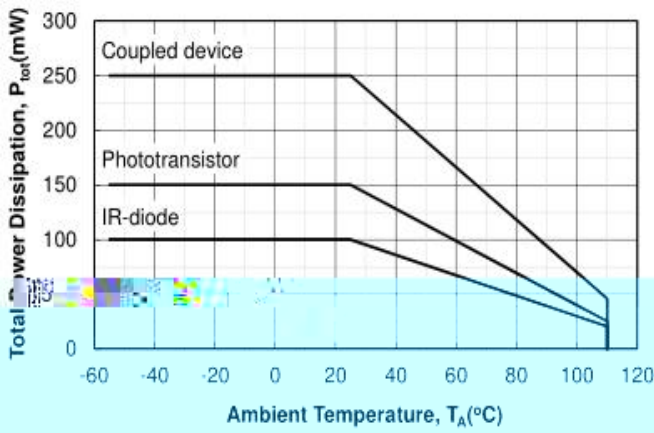

Figure 1. P_{tot} vs. T_A

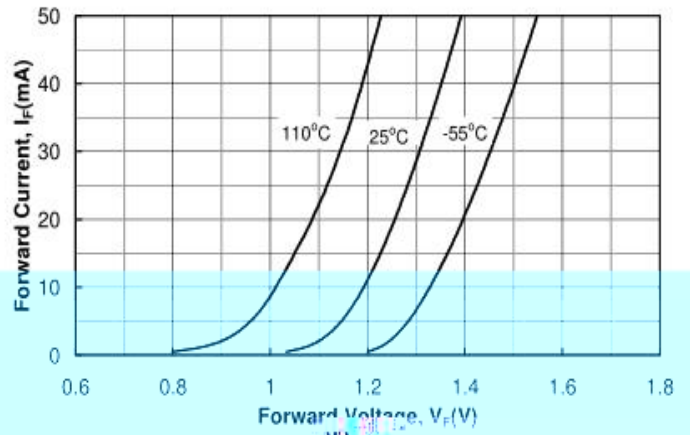
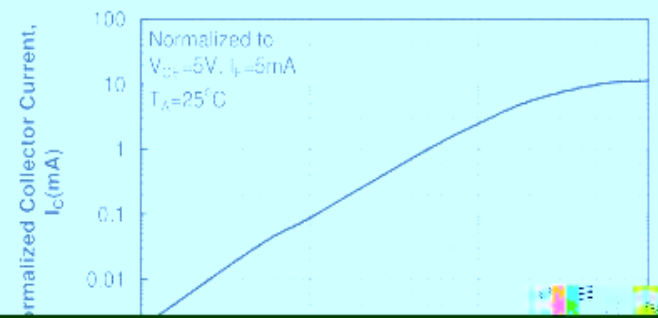
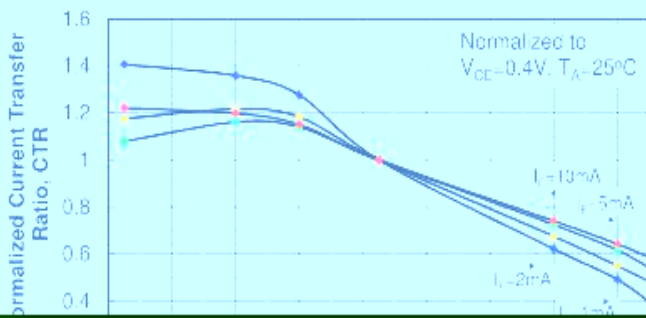

Figure 4. I_F vs. V_F



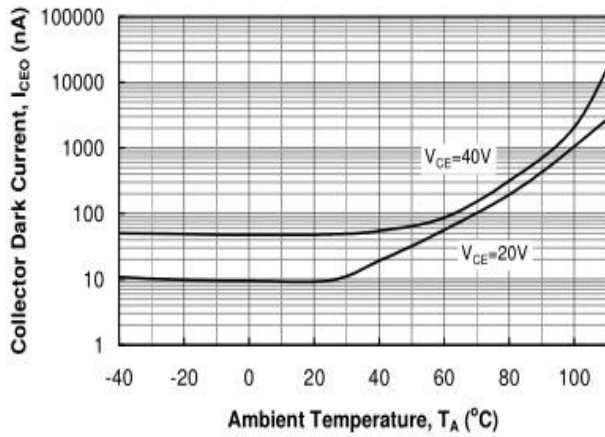

Figure 7. I_{CEO} vs. T_A

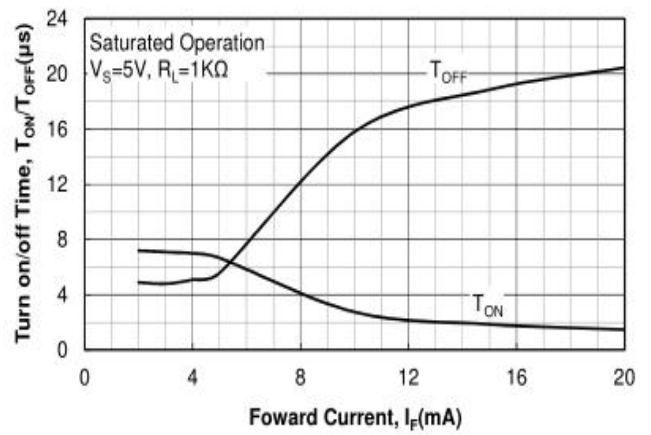

Figure 10. T_{ON} / T_{OFF} vs. I_F

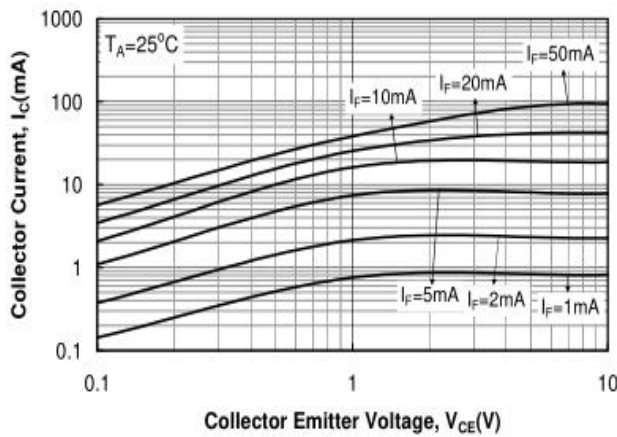

Figure 8. I_C vs. V_{CE}

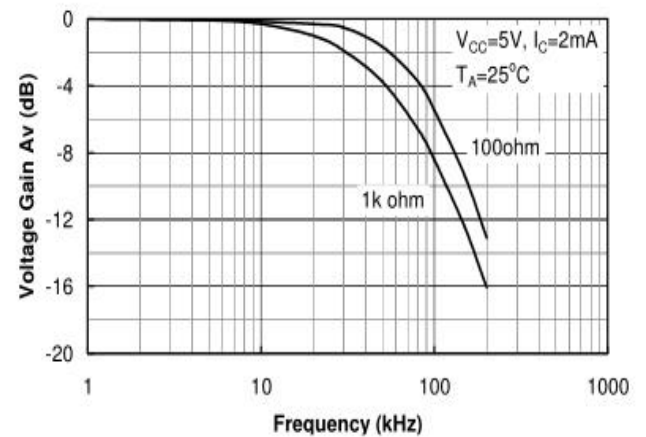

Figure 11. Frequency Response

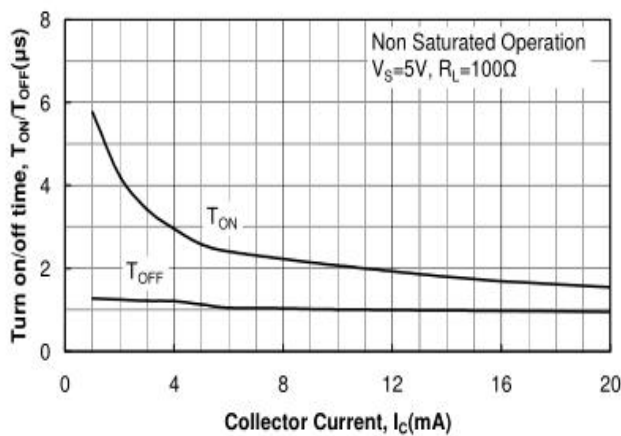

Figure 9. T_{ON} / T_{OFF} vs. I_C

